

SPECIALTY QUICK COUPLINGS

MULTIPLE MOUNTING

Easily Connects 3 to 5 Lines

- ✓ Leak Free, Easy Operation
- ✓ High Flow
- ✓ Thermoplastic or Chrome-Plated Brass
- ✓ Straight Thru, Double or Single End Shutoff
- ✓ Available for 3, 4, or 5 Coupling Mounts
- ✓ Keyed to Prevent Mismatches

Quick, convenient multiple couplings connect and disconnect several tubing lines at once and are easily made up from standard OMEGA® Quick Couplings. Multiple mounts are available in thermoplastic or chrome-plated brass, 1/8" and 1/4" flow sizes. Various materials, flow, weight and space requirements are accommodated.



FT-PMM/PLM Series

\$645

Basic Unit

Bodies

- Each multiple mount requires two standard panel mount coupling bodies.
- Remaining stations require multiple mount bodies. (see below)

Inserts

- Order required flow size and end configuration. (see next page).
- Retaining clip is included with each insert.
- Multiple mounting inserts are designed for mounting on 1/4" plates.

Coupling Mounting Plates

- Coupling plates are available for 3, 4, or 5 connections or construct your own plates.
- Keyed to prevent misconnections.

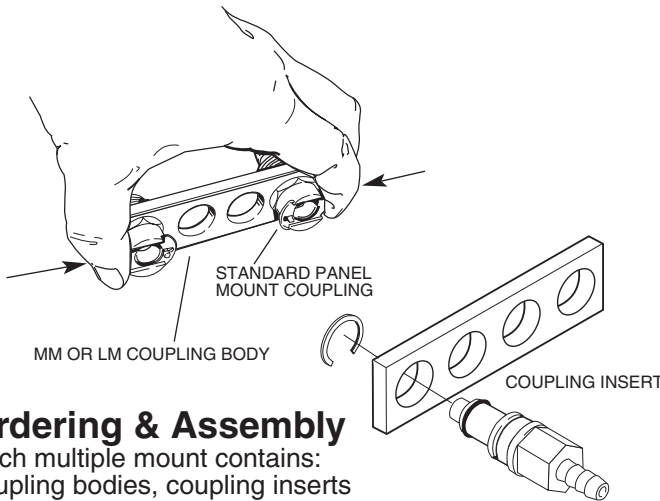

Ordering & Assembly

Each multiple mount contains: coupling bodies, coupling inserts and coupling plates.

Multiple Mount Bodies

MOST POPULAR MODELS HIGHLIGHTED!

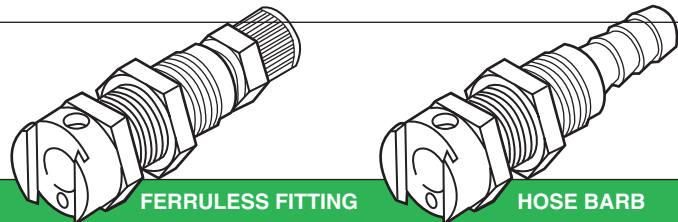

Ferruleless Polytube Fitting†, PTF

TUBING SIZE OD x ID	METRIC MM	FLOW	DELTRIN ACETAL STRAIGHT THRU	PRICE	SHUTOFF	PRICE	CHROME-PLATED BRASS STRAIGHT THRU	PRICE	SHUTOFF	PRICE
1/4" x 0.170"	6 x 4.3	1/8"	FT-PMM12-04	\$7.20	FT-PMMD12-04	\$8.07	FT-MM12-04	\$15.55	FT-MMD12-04	\$17.02
1/4" x 0.170"	6 x 4.3	1/4"	FT-PLM120-04	11.07	FT-PLMD120-04	12.07	FT-LM120-04	18.45	FT-LMD120-04	20.83
3/8" x 0.250"	9.5 x 6	1/4"	FT-PLM120-06	11.14	FT-PLMD120-06	12.24	FT-LM120-06	18.67	FT-LMD120-06	21.03

Hose Barb

1/8" ID	3.2 ID	1/8"	FT-PMM16-02	\$6.45	FT-PMMD16-02	\$7.40	FT-MM16-02	\$13.29	FT-MMD16-02	\$14.72
3/16" ID	4.8 ID	1/8"	FT-PMM16-03	6.45	FT-PMMD16-03	7.40	FT-MM16-03	13.42	FT-MMD16-03	15.00
1/4" ID	6.4 ID	1/8"	FT-PMM16-04	10.00	FT-PMMD16-04	7.40	FT-MM16-04	13.42	FT-MMD16-04	14.72
1/4" ID	6.4 ID	1/4"	FT-PLM160-04	10.03	FT-PLMD160-04	11.33	FT-LM160-04	17.15	FT-LMD160-04	19.35
5/16" ID	7.9 ID	1/4"	FT-PLM160-05	10.03	FT-PLMD160-05	11.33	FT-LM160-05	17.15	FT-LMD160-05	19.35
3/8" ID	9.5 ID	1/4"	FT-PLM160-06	10.03	FT-PLMD160-06	11.33	FT-LM160-06	17.15	FT-LMD160-06	19.35

†PTF fittings are designed for semi-rigid tubing i.e. polyethylene, nylon etc. and polyurethane tubing.

SPECIFICATIONS

Working Pressure:

Minimum: Vacuum

Maximum: $\frac{Brass = 500 \text{ psi}}{\text{no. of stations}}$ $\frac{Acetal = 240 \text{ psi}}{\text{no. of stations}}$

Mounting Plate: Anodized Aluminum

Materials:

Coupling Bodies: Chrome-Plated Brass or Delrin®/Celcon® Acetal

Valves: Delrin®/Celcon® Acetal

Valve Spring: 316 Stainless Steel

External Springs, Pin, Latch: Stainless Steel

Seals: Buna-N, others available

Operating Temperature: -40 to 82° C

(-40 to 180°F) continuous

Tubing Sizes: $\frac{1}{8}$ to $\frac{3}{8}$ " ID, $\frac{5}{16}$ to $\frac{3}{8}$ " OD, 4 x 2.5 mm to 8 x 12 mm (OD x ID)



Multiple Mount ruggedness and quick change capability meet machinery needs.

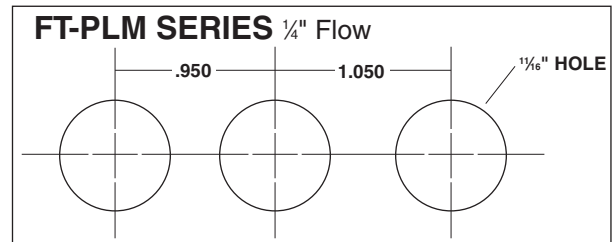
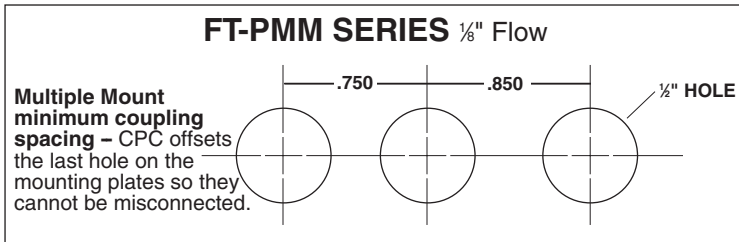

Multiple Mount Plates

MOST POPULAR MODELS HIGHLIGHTED!

STATIONS	$\frac{1}{8}$ " FLOW SIZE	LENGTH (in)	PRICE	$\frac{1}{4}$ " FLOW SIZE	RETAINING RINGS	PRICE	COUPLING	SERIES	PRICE
					LENGTH (in)				
3	FT-CP103	2.60	\$9.45	FT-LCP103	3.00	\$9.45	FT-MC/PMC	01017-00	\$0.20
4	FT-CP104	3.35	10.20	FT-LCP104	3.95	10.70	FT-LC/PLC	02781-00	0.20
5	FT-CP105	4.10	11.60	FT-LCP105	4.90	12.15			

Note: The first three models (FT-CP103, FT-CP104, FT-CP105) are highlighted in green in the original image.

Black Anodized Aluminum

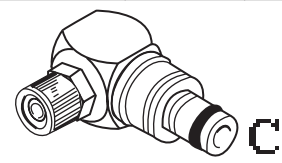
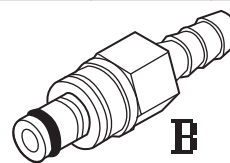
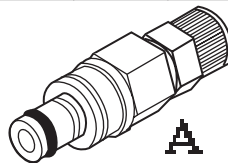

Multiple Mount Inserts

A Ferrules Polytube Fitting[†], PTF

TUBING SIZE OD x ID	METRIC MM	FLOW	DELRIN®/CELCON® ACETAL STRAIGHT THRU MODEL NO.	PRICE	SHUTOFF MODEL NO.	PRICE	CHROME-PLATED BRASS STRAIGHT THRU MODEL NO.	PRICE	SHUTOFF MODEL NO.	PRICE
$\frac{5}{16}$ x 0.100"	4 x 2.5	$\frac{1}{8}$ "	FT-PMM20-025	\$7.88	FT-PMMD20-025	\$11.30	FT-MM20-025	\$11.46	FT-MMD20-025	\$12.83
$\frac{1}{4}$ x 0.170"	6 x 4.3	$\frac{1}{4}$ "	FT-PMM20-04	7.75	FT-PMMD20-04	8.84	FT-MM20-04	10.76	FT-MMD20-04	12.50
$\frac{1}{4}$ x 0.170"	6 x 4.3	$\frac{1}{4}$ "	FT-PLM200-04	6.80	FT-PLMD200-04	10.71	FT-LM200-04	11.43	FT-LMD200-04	18.90
$\frac{3}{8}$ x 0.250"	9.5 x 6	$\frac{1}{4}$ "	FT-PLM200-06	6.98	FT-PLMD200-06	10.84	FT-LM200-06	11.64	FT-LMD200-06	19.08

B Hose Barb

$\frac{1}{8}$ " ID	3.2 ID	$\frac{1}{8}$ "	FT-PMM22-02	\$8.97	FT-PMMD22-02	\$8.84	FT-MM22-02	\$8.63	FT-MMD22-02	\$10.84
$\frac{3}{16}$ " ID	4.8 ID	$\frac{1}{8}$ "	FT-PMM22-03	7.48	FT-PMMD22-03	8.84	FT-MM22-03	8.80	FT-MMD22-03	11.04
$\frac{1}{4}$ " ID	6.4 ID	$\frac{1}{8}$ "	FT-PMM22-04	6.95	FT-PMMD22-04	8.84	FT-MM22-04	8.99	FT-MMD22-04	11.26
$\frac{1}{4}$ " ID	6.4 ID	$\frac{1}{4}$ "	FT-PLM220-04	5.43	FT-PLMD220-04	9.45	FT-LM220-04	8.80	FT-LMD220-04	16.02
$\frac{5}{16}$ " ID	7.9 ID	$\frac{1}{4}$ "	FT-PLM220-05	5.43	FT-PLMD220-05	9.45	FT-LM220-05	8.80	FT-LMD220-05	16.02
$\frac{3}{8}$ " ID	9.5 ID	$\frac{1}{4}$ "	FT-PLM220-06	5.43	FT-PLMD220-06	9.45	FT-LM220-06	8.80	FT-LMD220-06	16.02

C Hose Barb Elbow

$\frac{1}{4}$ x 0.170	6 x 4.3	$\frac{1}{8}$ "	FT-PMM21-04	\$8.15	FT-PMMD21-04	\$10.55	FT-MM21-04	\$14.90	FT-MMD21-04	\$17.55
-----------------------	---------	-----------------	--------------------	---------------	---------------------	----------------	-------------------	----------------	--------------------	----------------

Ordering Example: FT-PMM16-03, Delrin®/Celcon® acetal straight thru hose barb for $\frac{3}{16}$ " ID tubing, FT-PMM-22-03, Delrin®/Celcon® insert for $\frac{3}{16}$ " ID tubing, \$6.45 + 7.48 = \$13.93

omega.co.uk[®]

Your One-Stop Source for Process Measurement and Control!

Freephone 0800 488 488 | International +44(0) 161 777 6622 | Fax +44(0) 161 777 6622 | Sales@omega.co.uk

www.omega.co.uk



UNITED STATES

www.omega.com

1-800-TC-OMEGA
Stamford, CT.

UNITED KINGDOM

www.omega.co.uk

Manchester, England
0800-488-488
+44-(0)161-777-6611

CANADA

www.omega.ca

Laval(Quebec)
1-800-TC-OMEGA

FRANCE

www.omega.fr

0800-466-342

GERMANY

www.omega.de

Deckenfronn, Germany
0800-8266342

BENELUX

www.omega.nl

0800-099-33-44



More than 100,000 Products Available!

• Temperature

Calibrators, Connectors, General Test and Measurement Instruments, Handheld Instruments for Temperature Measurement, Ice Point References, Indicating Labels, Crayons, Cements and Lacquers, Infrared Temperature Measurement Instruments, Recorders, Relative Humidity Measurement Instruments, PT100 Probes, PT100 Elements, Temperature & Process Meters, Timers and Counters, Temperature and Process Controllers and Power Switching Devices, Thermistor Elements, Probes and Assemblies, Thermocouples, Thermowells and Head and Well Assemblies, Transmitters, Thermocouple Wire, RTD Probes

• Flow and Level

Air Velocity Indicators, Doppler Flowmeters, Level Measurement, Magnetic Flowmeters, Mass Flowmeters, Pitot Tubes, Pumps, Rotameters, Turbine and Paddle Wheel Flowmeters, Ultrasonic Flowmeters, Valves, Variable Area Flowmeters, Vortex Shedding Flowmeters

• pH and Conductivity

Conductivity Instrumentation, Dissolved Oxygen Instrumentation, Environmental Instrumentation, pH Electrodes and Instruments, Water and Soil Analysis Instrumentation

• Data Acquisition

Communication Products and Converters, Data Acquisition and Analysis Software, Data Loggers Plug-in Cards, Signal Conditioners, USB, RS232, RS485, Ethernet and Parallel Port Data Acquisition Systems, Wireless Transmitters and Receivers

• Pressure, Strain and Force

Displacement Transducers, Dynamic Measurement Force Sensors, Instrumentation for Pressure and Strain Measurements, Load Cells, Pressure Gauges, Pressure Reference Section, Pressure Switches, Pressure Transducers, Proximity Transducers, Regulators, Pressure Transmitters, Strain Gauges, Torque Transducers, Valves

• Heaters

Band Heaters, Cartridge Heaters, Circulation Heaters, Comfort Heaters, Controllers, Meters and Switching Devices, Flexible Heaters, General Test and Measurement Instruments, Heater Hook-up Wire, Heating Cable Systems, Immersion Heaters, Process Air and Duct, Heaters, Radiant Heaters, Strip Heaters, Tubular Heaters