

Soft Tube Fittings

REDUCE LABOR COSTS WITH CLAMP-FREE CONNECTIONS

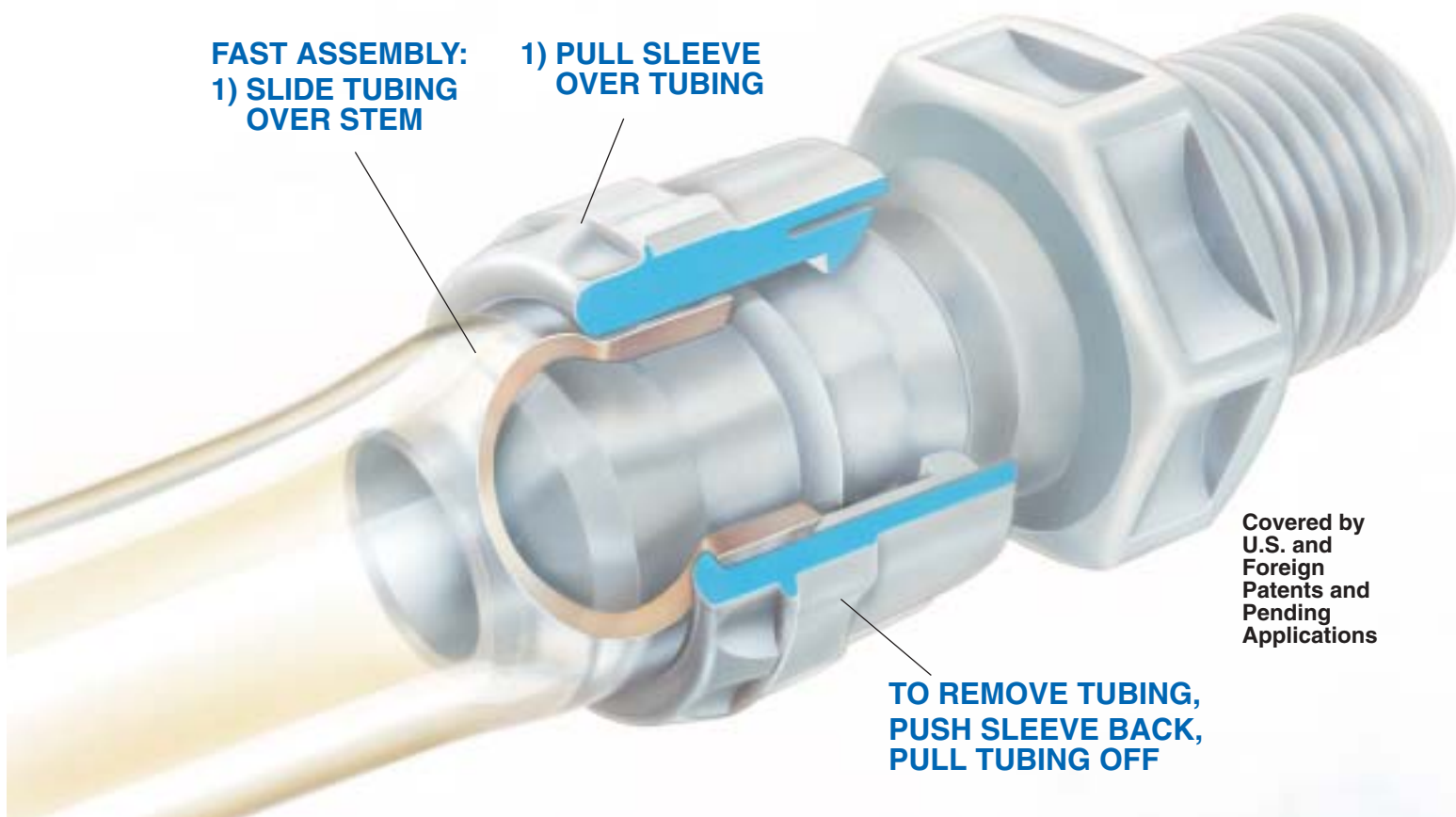

FAST ASSEMBLY:
1) SLIDE TUBING
OVER STEM

1) PULL SLEEVE
OVER TUBING

Covered by
U.S. and
Foreign
Patents and
Pending
Applications

**TO REMOVE TUBING,
PUSH SLEEVE BACK,
PULL TUBING OFF**



CLAMP-FREE CONNECTIONS FOR SOFT TUBING

Now you can make secure, leak-free connections to soft, walled tubing without hose clamps or tools. Soft tube fittings make it easy for anyone to make a reliable connection every time. The soft tube stem makes a 360° seal on the tubing ID. Then the self-adjusting sleeve secures the tubing from pulling out or blowing off.

LABORATORY APPLICATIONS

Polypropylene fittings meet lab requirements for chemical resistance. Easy to assemble. Soft tube fittings are ideal for the changing needs of a lab.

OTHER BENEFITS

- Consistent appearance
- Uniform assembly by anyone
- Attractive and compact size
- Serviceability – remove tubing without damage
- Special configurations and sizes for custom applications

FITTING SPECIFICATIONS

Pressure: Maximum operating pressure of fitting: 120 psi, 8.3 Bar
 Temperature: 0°C to 82°C continuous
 32°F to 180°F continuous
 Materials: Body–Polypropylene
 Sleeve–Delrin Acetal

Color: Gray; others available

TUBING SPECIFICATIONS

Types: 50-90 durometer, vinyl, Viton®, urethane, neoprene, Tygon

Sizes: 1/4" ID x 3/8" OD & 1/16" wall
 3/8" ID x 1/2" OD & 1/16" wall
 1/2" ID x 3/4" OD & 1/8" wall







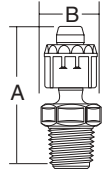

HOW TO SELECT SOFT TUBE FITTINGS

1. Choose configuration – *i.e.*, Male Branch Tee
2. Select tube size desired – *i.e.*, 1/4" ID x 3/8" OD
3. Determine thread size if needed – *i.e.*, 1/4" NPTF
4. Order part number – *i.e.*, FT-ST 30-04-04

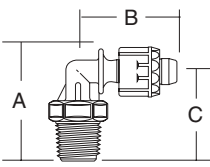
ADDITIONAL PRODUCTS

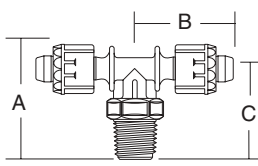
OMEGA can solve your special fitting needs. Our engineers will work with you on your application.

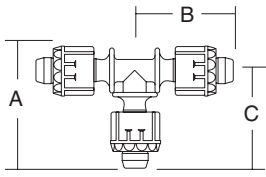

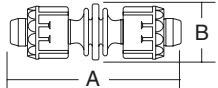
	TUBING SIZE	THREADS	MODEL NUMBER	PRICE/ PK of 5	DIMENSIONS			HEX SIZE
	ID x OD				A	B	C	
MALE STRAIGHT  	1/4" x 3/8"	1/8" NPTF	FT-ST10-02-04	\$8.70	1.540"	.400"		5/8"
		1/4" NPTF	FT-ST10-04-04	8.70	1.640"	.500"		5/8"
	3/8" x 1/2"	1/4" NPTF	FT-ST10-04-06	11.05	1.850"	.500"		3/4"
		3/8" NPTF	FT-ST10-06-06	11.05	1.850"	.500"		3/4"
	1/2" x 3/4"	3/8" NPTF	FT-ST10-06-08	12.55	2.450"	.500"		1"
	1/2" NPTF	FT-ST10-08-08	12.55	2.600"	.650"		1"	
MALE ELBOW  	1/4" x 3/8"	1/8" NPTF	FT-ST20-02-04	13.05	1.343"	1.200"	1.030"	5/8"
		1/4" NPTF	FT-ST20-04-04	13.05	1.443"	1.200"	1.130"	5/8"
	3/8" x 1/2"	1/4" NPTF	FT-ST20-04-06	15.00	1.615"	1.430"	1.240"	3/4"
		3/8" NPTF	FT-ST20-06-06	15.00	1.615"	1.430"	1.240"	3/4"
	1/2" x 3/4"	3/8" NPTF	FT-ST20-06-08	16.95	1.940"	2.070"	1.440"	1"
	1/2" NPTF	FT-ST20-08-08	16.95	2.090"	2.070"	1.590"	1"	
MALE BRANCH TEE  	1/4" x 3/8"	1/8" NPTF	FT-ST30-02-04	15.00	1.343"	1.200"	1.030"	5/8"
		1/4" NPTF	FT-ST30-04-04	15.00	1.443"	1.200"	1.130"	5/8"
	3/8" x 1/2"	1/4" NPTF	FT-ST30-04-06	16.95	1.615"	1.430"	1.240"	3/4"
		3/8" NPTF	FT-ST30-06-06	16.95	1.615"	1.430"	1.240"	3/4"
	1/2" x 3/4"	3/8" NPTF	FT-ST30-06-08	18.90	1.940"	2.070"	1.440"	1"
	1/2" NPTF	FT-ST30-08-08	18.90	2.090"	2.070"	1.590"	1"	
UNION TEE  	1/4" x 3/8"		FT-ST32-04	19.80	1.530"	1.200"	1.200"	
	3/8" x 1/2"		FT-ST32-06	22.15	1.805"	1.430"	1.430"	
	1/2" x 3/4"		FT-ST32-08	25.60	2.570"	2.070"	2.070"	
UNION  	1/4" x 3/8"		FT-ST40-04	14.20	2.080"	.680"		
	3/8" x 1/2"		FT-ST40-06	16.15	2.380"	.800"		
	1/2" x 3/4"		FT-ST40-08	18.15	3.430"	1.030"		

In stock for fast delivery. 

omega.co.uk[®]

Your One-Stop Source for Process Measurement and Control!

Freephone 0800 488 488 | International +44(0) 161 777 6622 | Fax +44(0) 161 777 6622 | Sales@omega.co.uk

www.omega.co.uk



UNITED STATES

www.omega.com

1-800-TC-OMEGA
Stamford, CT.

UNITED KINGDOM

www.omega.co.uk

Manchester, England
0800-488-488
+44-(0)161-777-6611

CANADA

www.omega.ca

Laval(Quebec)
1-800-TC-OMEGA

FRANCE

www.omega.fr

0800-466-342

GERMANY

www.omega.de

Deckenfronn, Germany
0800-8266342

BENELUX

www.omega.nl

0800-099-33-44



More than 100,000 Products Available!

• Temperature

Calibrators, Connectors, General Test and Measurement Instruments, Handheld Instruments for Temperature Measurement, Ice Point References, Indicating Labels, Crayons, Cements and Lacquers, Infrared Temperature Measurement Instruments, Recorders, Relative Humidity Measurement Instruments, PT100 Probes, PT100 Elements, Temperature & Process Meters, Timers and Counters, Temperature and Process Controllers and Power Switching Devices, Thermistor Elements, Probes and Assemblies, Thermocouples, Thermowells and Head and Well Assemblies, Transmitters, Thermocouple Wire, RTD Probes

• Flow and Level

Air Velocity Indicators, Doppler Flowmeters, Level Measurement, Magnetic Flowmeters, Mass Flowmeters, Pitot Tubes, Pumps, Rotameters, Turbine and Paddle Wheel Flowmeters, Ultrasonic Flowmeters, Valves, Variable Area Flowmeters, Vortex Shedding Flowmeters

• pH and Conductivity

Conductivity Instrumentation, Dissolved Oxygen Instrumentation, Environmental Instrumentation, pH Electrodes and Instruments, Water and Soil Analysis Instrumentation

• Data Acquisition

Communication Products and Converters, Data Acquisition and Analysis Software, Data Loggers Plug-in Cards, Signal Conditioners, USB, RS232, RS485, Ethernet and Parallel Port Data Acquisition Systems, Wireless Transmitters and Receivers

• Pressure, Strain and Force

Displacement Transducers, Dynamic Measurement Force Sensors, Instrumentation for Pressure and Strain Measurements, Load Cells, Pressure Gauges, Pressure Reference Section, Pressure Switches, Pressure Transducers, Proximity Transducers, Regulators, Pressure Transmitters, Strain Gauges, Torque Transducers, Valves

• Heaters

Band Heaters, Cartridge Heaters, Circulation Heaters, Comfort Heaters, Controllers, Meters and Switching Devices, Flexible Heaters, General Test and Measurement Instruments, Heater Hook-up Wire, Heating Cable Systems, Immersion Heaters, Process Air and Duct, Heaters, Radiant Heaters, Strip Heaters, Tubular Heaters